



# Spare parts price list

## Let's Goal



PPHU „Ritter” Rycerz Michał

Ul. Rudzka 13B  
44-240 Żory

serwis@ritter-polska.pl  
NIP:6511661504

|                              |    |
|------------------------------|----|
| 1. Elektronik.....           | 5  |
| 2. Accessories.....          | 12 |
| 3. Stickers and covers ..... | 31 |



|   |    |
|---|----|
| 1.1 Mainboard Let's Goal_250€.....                  | 6  |
| 1.2 Display 2x23 _40€.....                          | 7  |
| 1.3 Display 3x56 _35€.....                          | 8  |
| 1.4 Pilot DISP 2*16 LCD_30€.....                    | 9  |
| 1.5 BARIERA IR 2x1_35€ .....                        | 10 |
| 1.6 Interface _10€ .....                            | 11 |
| 2.1 Power Supply LRS-150-12 150W 12V 12,5A_35€..... | 13 |
| 2.2 Speaker 165mm 150W_20€ .....                    | 14 |
| 2.3 Panel CP Alberici_7€.....                       | 15 |
| 2.4 Coin acceptor Alberici_120€.....                | 16 |
| 2.5 Start button freeplay_15€ .....                 | 17 |
| 2.6 Cover actuator_18€.....                         | 18 |
| 2.7 Cover hinge_6€.....                             | 19 |
| 2.8 Spring vibration isolator_30€ .....             | 20 |
| 2.9 Rubber bumper_4€.....                           | 21 |
| 2.10 Mechanism motor_45€.....                       | 22 |



|   |    |
|---|----|
| 2.11 Game ball_2€ .....                           | 23 |
| 2.12 Combination lock_15€ .....                   | 24 |
| 2.13 Goal screw_2€ .....                          | 25 |
| 2.14 Transport wheel_12€ .....                    | 26 |
| 2.15 Controller LED_10€ .....                     | 27 |
| 2.16 Micro SDHC_10€ .....                         | 28 |
| 2.17 Plastic insert for cash box_10€ .....        | 29 |
| 2.18 Ball outlet cover_2€ .....                   | 30 |
| 3.1 Side stickers_30€ .....                       | 32 |
| 3.2 Side stickers_60€ .....                       | 33 |
| 3.3 Cover PC_100€ 1x2m .....                      | 34 |
| 3.4 Mechanism cover_30€ .....                     | 35 |
| 3.5 Displays PC_10€ .....                         | 36 |
| 3.6 One side of the PC bumper - movable_20€ ..... | 37 |



# 1. Electronics



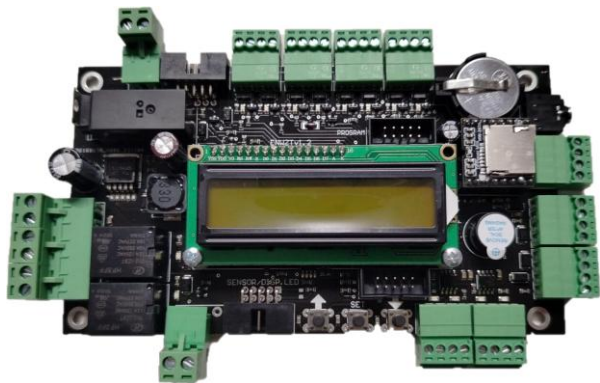

1.1 Mainboard Let's Goal\_250€



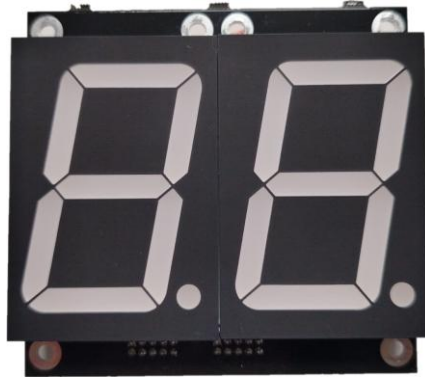

1.2 Display 2x23 \_40€





1.3 Display 3x56\_35€





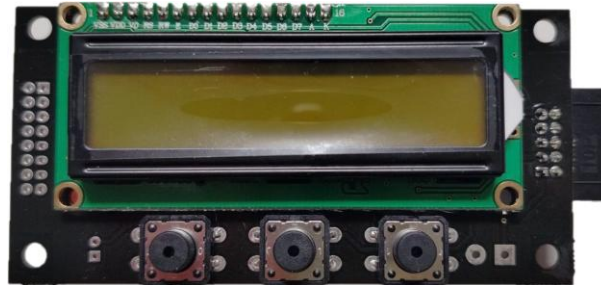

1.4 Pilot DISP 2\*16 LCD\_30€

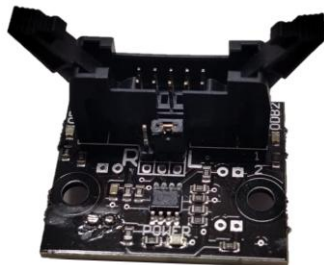

1.5 BARRIERA IR 2x1\_35€

**LET'S  
GOAL!**

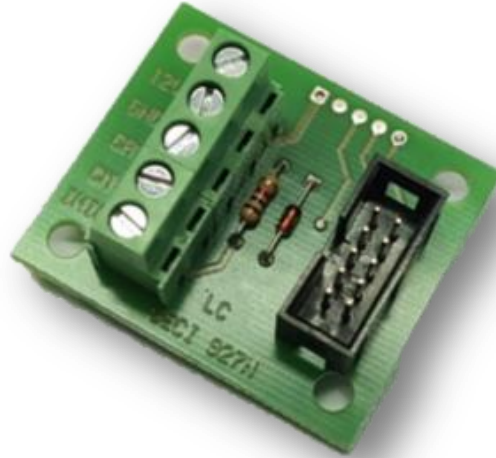

1.6 Interface\_10€

# 2. Accessories





2.1 Power Supply LRS-150-12 150W 12V 12,5A\_35€



2.2 Speaker 165mm 150W\_20€

**LET'S  
GOAL!**



2.3 Panel CP Alberici\_7€





2.4 Coin acceptor Alberici\_120€







2.5 Start button freeplay\_15€

**LET'S  
GOAL!**



2.6 Cover actuator\_18€





2.7 Cover hinge\_6€

**LET'S  
GOAL!**



2.8 Spring vibration isolator\_30€





2.9 Rubber bumper\_4€





2.10 Mechanism motor \_45€





2.11 Game ball\_2€

**LET'S  
GOAL!**



2.12 Combination lock\_15€

**LET'S  
GOAL!**



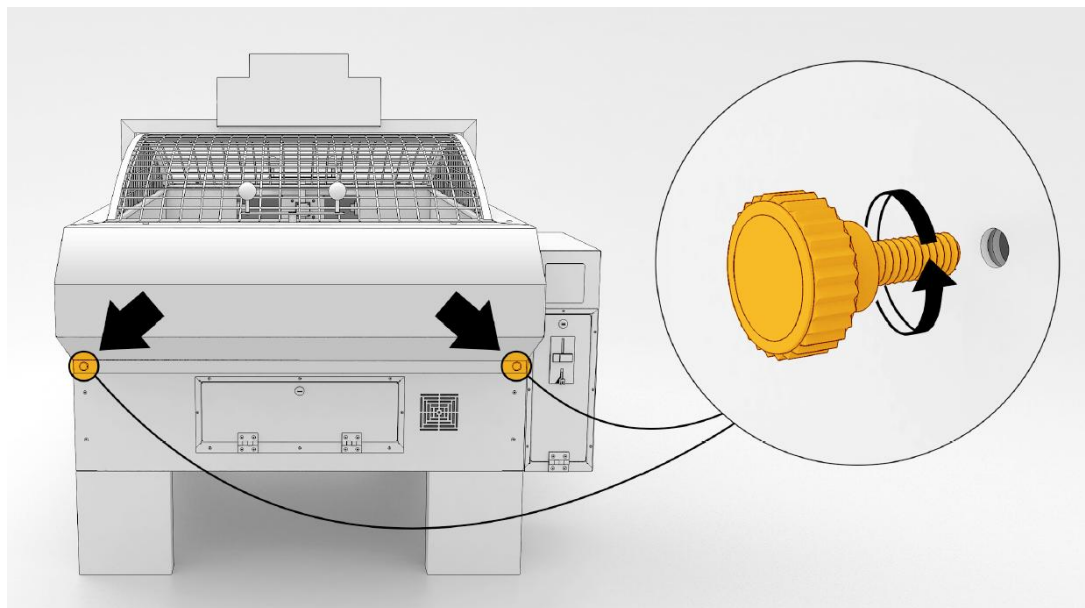

2.13 Goal screw\_2€



2.14 Transport wheel\_12€





2.15 Controller LED\_10€





2.16 Micro SDHC\_10€





2.17 Plastic insert for cash box\_10€



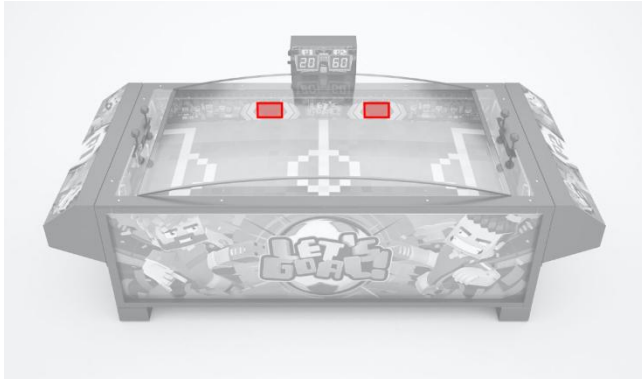

2.18 Ball outlet cover\_2€



# 3. Stickers and covers





3.1 Side stickers\_30€



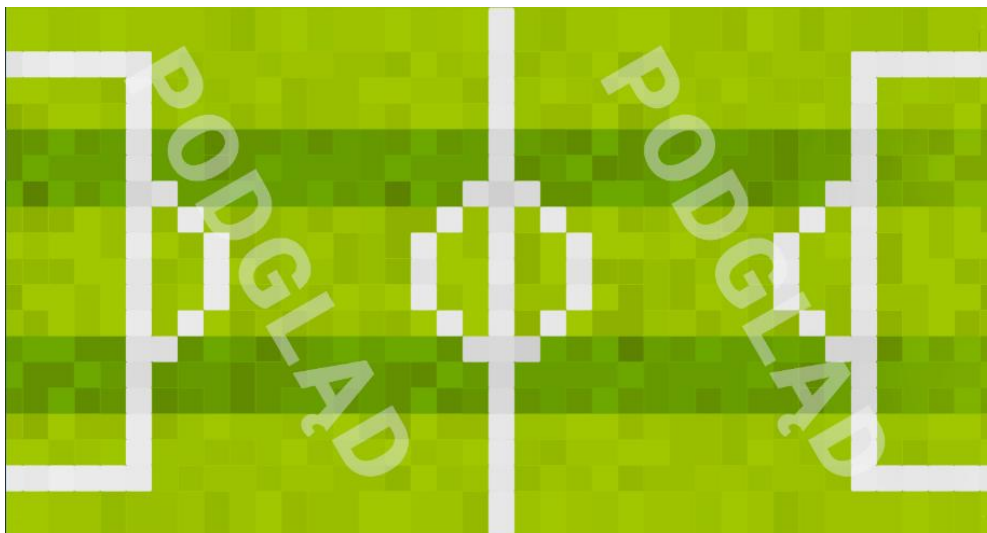

3.2 Side stickers \_60€





3.3 Cover PC\_100€ 1x2m



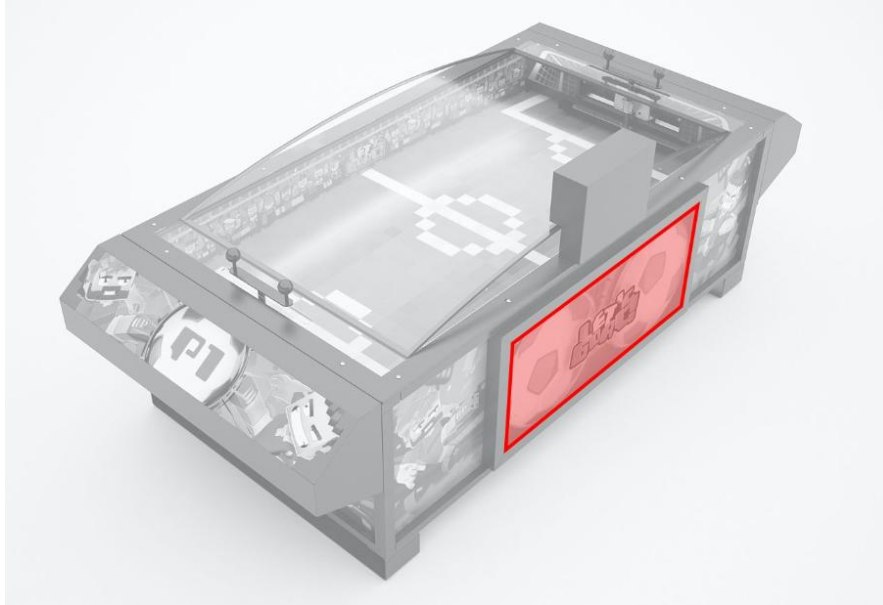

3.4 Mechanism cover\_30€



3.5 Displays PC\_10€





3.6 One side of the PC bumper - movable\_20€

